

► SPECIFICATIONS

Alldrive 3 Tonne Powerswivel

HYDROSTATIC

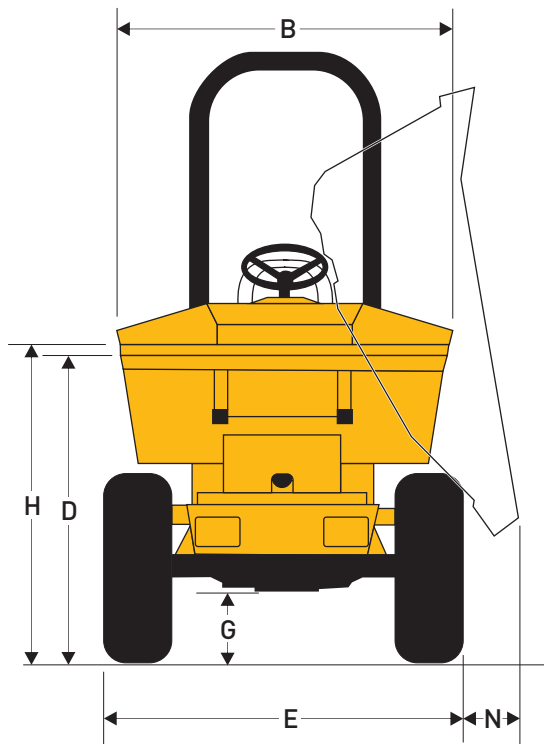
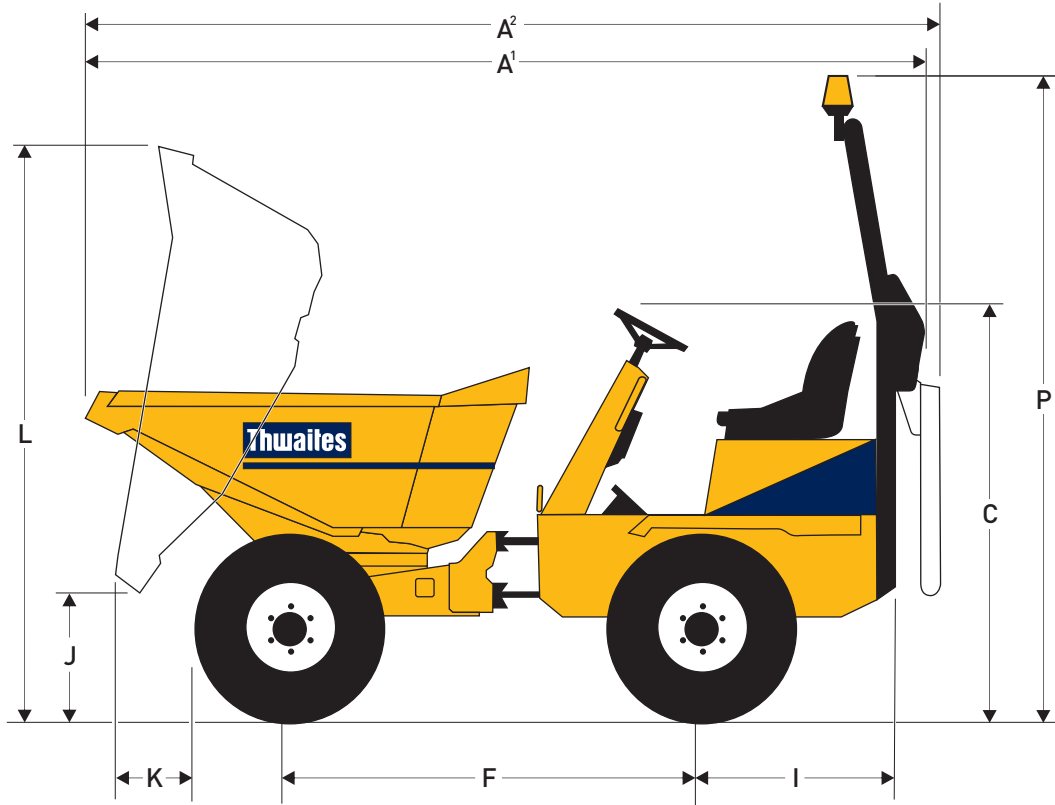

Dimensions
(mm)

A ¹	3935
A ²	4100
B	1650
C	1965
D	1440
E	1650
F	1950
G	330
H	1565
I	1032
J	735
K	510
L	2825
N	364
P	3092

SPECIFICATIONS

Alldrive 3 Tonne Powerswivel

HYDROSTATIC

Capacities	Max. safe load	3000 kg
	Heaped	1640 litres
	Struck	1210 litres
	Water	990 litres

Engine

Yanmar 3TNV88, 24.8 kW/33.2 bhp (nett) at 2800 rpm, 3 cylinder water-cooled direct-injection diesel. Max. torque 111 Nm (82 lbf ft). Electric starting, hour meter, battery isolator switch and heavy duty cyclonic air cleaner positioned within the lockable engine compartment.

Noise Levels

Operator's ear 84 LpA, airborne sound power level 101 LwA (to 2000/14/EC).

Transmission

Hydrostatic with high/low speed range and forward/reverse direction controlled by one column-mounted lever. Inching facility for precise manoeuvres in restricted areas activated by first push on brake pedal.

Speeds	Forward and reverse	
	Low	0-8.5 km/h (5.3 mph)
	High	0-22.0 km/h (13.7 mph)

Tyres	295/80 x 15.3
	10 ply
	Track grip tread

Brakes and Axles

Totally enclosed multiplate oil-immersed discs mounted on rear axle effective on all four wheels. Automatic adjustment for wear. Hand-operated parking brake. Heavy-duty axles with epicyclic reduction and fully floating halfshafts.

Kinglink Chassis

Front and rear chassis constructed from deep-section folded steel plate, with three-point Kinglink giving centre articulation and oscillation for better stability, traction and extra safety on site. Remote greasing point provided for lubrication of top Kinglink articulation pin.

Skip

Hydraulically operated, 6 mm steel base plate, fully welded, mouth and sides of skip reinforced with box sections giving greater strength to minimise skip damage. No material traps. Powerswivel mounted on ball bearing turntable with powered rotation through 180° by means of twin slewing cylinders, operated by a single dual axis control lever. Automatic safety lock holds skip in central position when travelling.

Seating & Controls

Adjustable suspension seat, accessible from both sides. Audible warning device at key start 'on' position. Super-bright warning lights for all critical functions. Electric horn. Large pedal pads with handbrake and hydraulic controls ready to hand.

Service Access

Lockable three-sided cover opens to provide easy access from ground level to engine service points, all located on the same side. Moulded diesel and hydraulic tanks positioned low in the chassis side members, permitting access to the filler caps from ground level.

Electrics

Wiring harness contained within conduits and all electrical components water resistant to IP65/67 standards.

Steering & Hydraulics

Hydraulic priority power steering. Filter mounted on the top of the tank accessible from ground level. Combined suction and return filtration for all services. Hydraulic test points fitted as standard.

Tank capacities	Fuel	24.5 litres
	Hydraulic	25 litres

Shipping Cube	13 m ³ (with folded ROPS)
---------------	--------------------------------------

Unladen Weight	2190 kg
----------------	---------

Clearance Diameter	8.0 m
--------------------	-------

Towing Bracket	Standard
----------------	----------

ROPS

For the UK and other markets where it is a legal requirement a fully approved folding ROPS frame is fitted as standard.

Optional Extras

Folding ROPS frame. Beacon. Full road lighting equipment. UK road equipment. Anti-theft device.

Thwaites

Thwaites Ltd. Leamington Spa, Warwickshire CV32 7NQ, England
Tel +44 (0)1926 422471 Fax +44 (0)1926 337155
www.thwaitesdumpers.co.uk

Distributor



We reserve the right to change all specifications without prior notice. Printed in England 09/2007.